

**CTLSH01-30**  
**SURFACE MOUNT SILICON**  
**SCHOTTKY DIODE**



[www.centrasemi.com](http://www.centrasemi.com)



Top View    Bottom View  
**TLM2D3D6 CASE**

**DESCRIPTION:**

The CENTRAL SEMICONDUCTOR CTLSH01-30 is a high quality Schottky Diode designed for applications where ultra small size and power dissipation are prime requirements. Packaged in a TLM2D3D6 package, this component provides performance characteristics suitable for the most demanding size constrained applications.

**MARKING CODE: C**

**APPLICATIONS:**

- DC-DC converters
- Voltage clamping
- Protection circuits
- Battery powered applications including cell phones, digital cameras, pagers, PDAs, laptop computers, etc.

**FEATURES:**

- Current ( $I_O=100\text{mA}$ )
- Low forward voltage drop ( $V_F=0.41\text{V TYP @ }10\text{mA}$ )
- Low reverse current ( $30\text{nA TYP @ }10\text{V}$ )
- Ultra small, ultra low profile  $0.3\text{mm} \times 0.6\text{mm} \times 0.3\text{mm}$  leadless surface mount package

**MAXIMUM RATINGS:** ( $T_A=25^\circ\text{C}$ )

Peak Repetitive Reverse Voltage  
 Average Forward Current  
 Peak Forward Surge Current,  $t_p=8.3\text{ms}$   
 Power Dissipation  
 Operating Junction Temperature  
 Storage Temperature  
 Thermal Resistance

**SYMBOL**

SYMBOL		UNITS
$V_{RRM}$	30	V
$I_O$	100	mA
$I_{FSM}$	500	mA
$P_D$	100	mW
$T_J$	-65 to +125	$^\circ\text{C}$
$T_{stg}$	-65 to +150	$^\circ\text{C}$
$\theta_{JA}$	1000	$^\circ\text{C/W}$

**ELECTRICAL CHARACTERISTICS:** ( $T_A=25^\circ\text{C}$  unless otherwise noted)

SYMBOL	TEST CONDITIONS	MIN	TYP	MAX	UNITS
$I_R$	$V_R=10\text{V}$		30	300	nA
$BV_R$	$I_R=100\mu\text{A}$	30			V
$V_F$	$I_F=10\text{mA}$		0.41	0.46	V
$C_J$	$V_R=0, f=1.0\text{MHz}$		7.0		pF

**CTLSH01-30**  
**SURFACE MOUNT SILICON**  
**SCHOTTKY DIODE**



**TLM2D3D6 CASE - MECHANICAL OUTLINE**

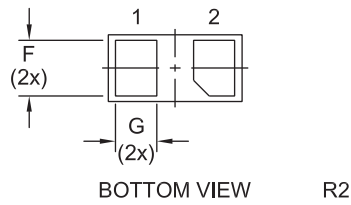
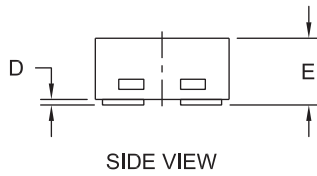
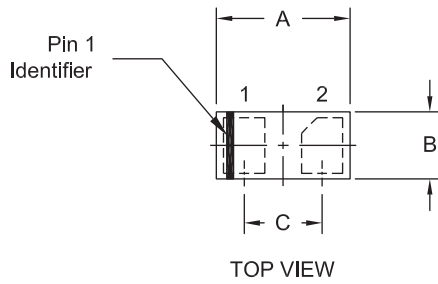

SYMBOL	DIMENSIONS			
	INCHES		MILLIMETERS	
	MIN	MAX	MIN	MAX
A	0.022	0.026	0.55	0.65
B	0.010	0.014	0.25	0.35
C	0.014		0.35	
D	0.000	0.002	0.00	0.05
E	0.011	0.013	0.28	0.32
F	0.008	0.012	0.20	0.30
G	0.005	0.009	0.13	0.24

TLM2D3D6 (REV: R2)

**LEAD CODE:**

- 1) Cathode
- 2) Anode

**MARKING CODE: C**

R4 (29-September 2015)

**CTLSH01-30**  
**SURFACE MOUNT SILICON**  
**SCHOTTKY DIODE**



**TYPICAL ELECTRICAL CHARACTERISTICS**

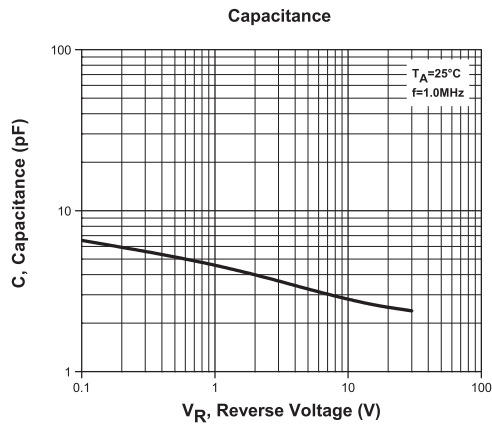
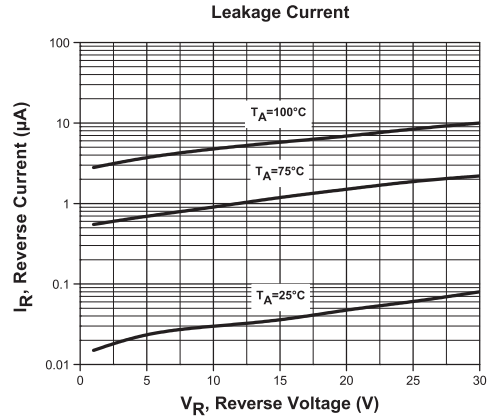
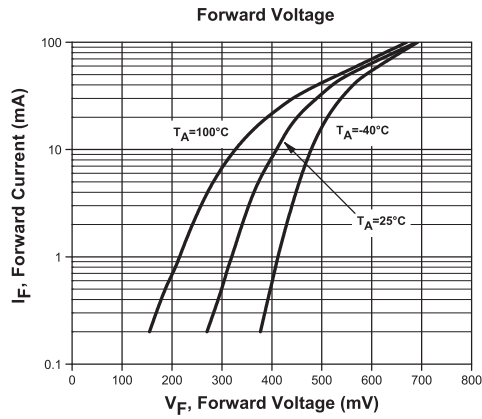

R4 (29-September 2015)

CTLSH01-30  
SURFACE MOUNT SILICON  
SCHOTTKY DIODE



TYPICAL ELECTRICAL CHARACTERISTICS

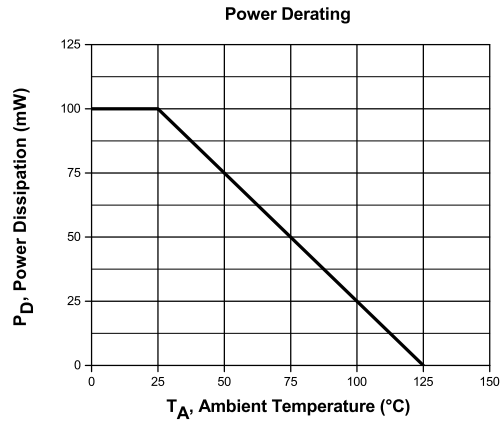
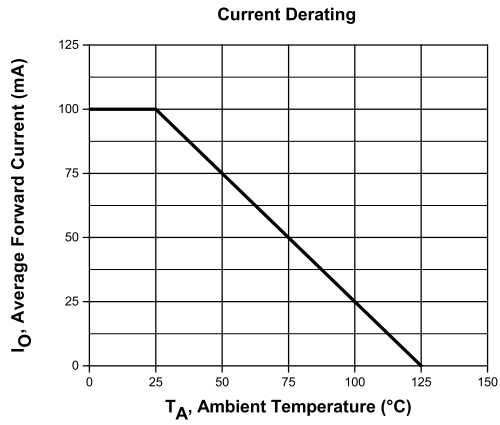

R4 (29-September 2015)

## OUTSTANDING SUPPORT AND SUPERIOR SERVICES



---

### PRODUCT SUPPORT

Central's operations team provides the highest level of support to insure product is delivered on-time.

- Supply management (Customer portals)
- Inventory bonding
- Consolidated shipping options
- Custom bar coding for shipments
- Custom product packing

---

### DESIGNER SUPPORT/SERVICES

Central's applications engineering team is ready to discuss your design challenges. Just ask.

- Free quick ship samples (2<sup>nd</sup> day air)
- Online technical data and parametric search
- SPICE models
- Custom electrical curves
- Environmental regulation compliance
- Customer specific screening
- Up-screening capabilities
- Special wafer diffusions
- PbSn plating options
- Package details
- Application notes
- Application and design sample kits
- Custom product and package development

---

### CONTACT US

#### Corporate Headquarters & Customer Support Team

Central Semiconductor Corp.  
145 Adams Avenue  
Hauppauge, NY 11788 USA  
Main Tel: (631) 435-1110  
Main Fax: (631) 435-1824  
Support Team Fax: (631) 435-3388  
[www.centalsemi.com](http://www.centalsemi.com)

**Worldwide Field Representatives:**  
[www.centalsemi.com/wwreps](http://www.centalsemi.com/wwreps)

**Worldwide Distributors:**  
[www.centalsemi.com/wwdistributors](http://www.centalsemi.com/wwdistributors)

---

For the latest version of Central Semiconductor's **LIMITATIONS AND DAMAGES DISCLAIMER**, which is part of Central's Standard Terms and Conditions of sale, visit: [www.centalsemi.com/terms](http://www.centalsemi.com/terms)